

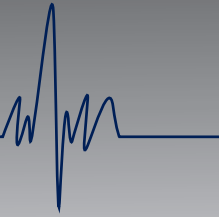

Solutions Start Here...



**Solutions Start Here**  
[www.smpcanada.com](http://www.smpcanada.com)

**SMP Canada**  
10 Sims Crescent, Richmond Hill  
Ontario, L4B-1K9 Canada  
Tel: (905) 764-7767 Fax: 1-866-627-9798  
[support@smpcanada.com](mailto:support@smpcanada.com)

## OXYGEN REGULATOR

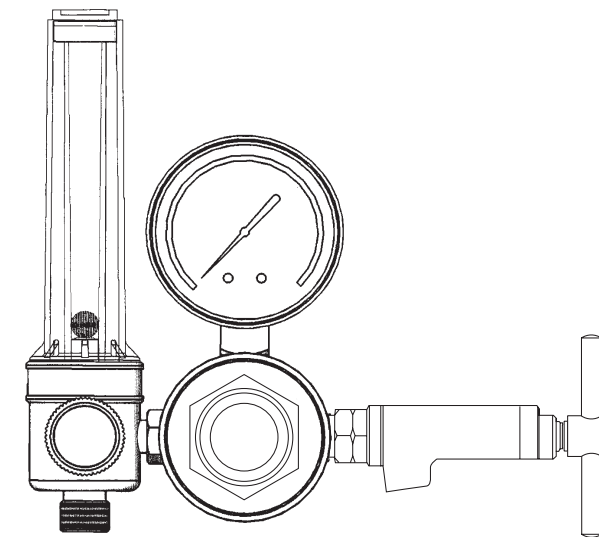

**FDA** **CE**<sup>0434</sup> **GMP** ISO 13485:2003 CERTIFIED

**USER & MAINTENANCE MANUAL**



# USER MANUAL

## RESPIRATORY CARE OXYGEN REGULATOR

### ORDERING GUIDE

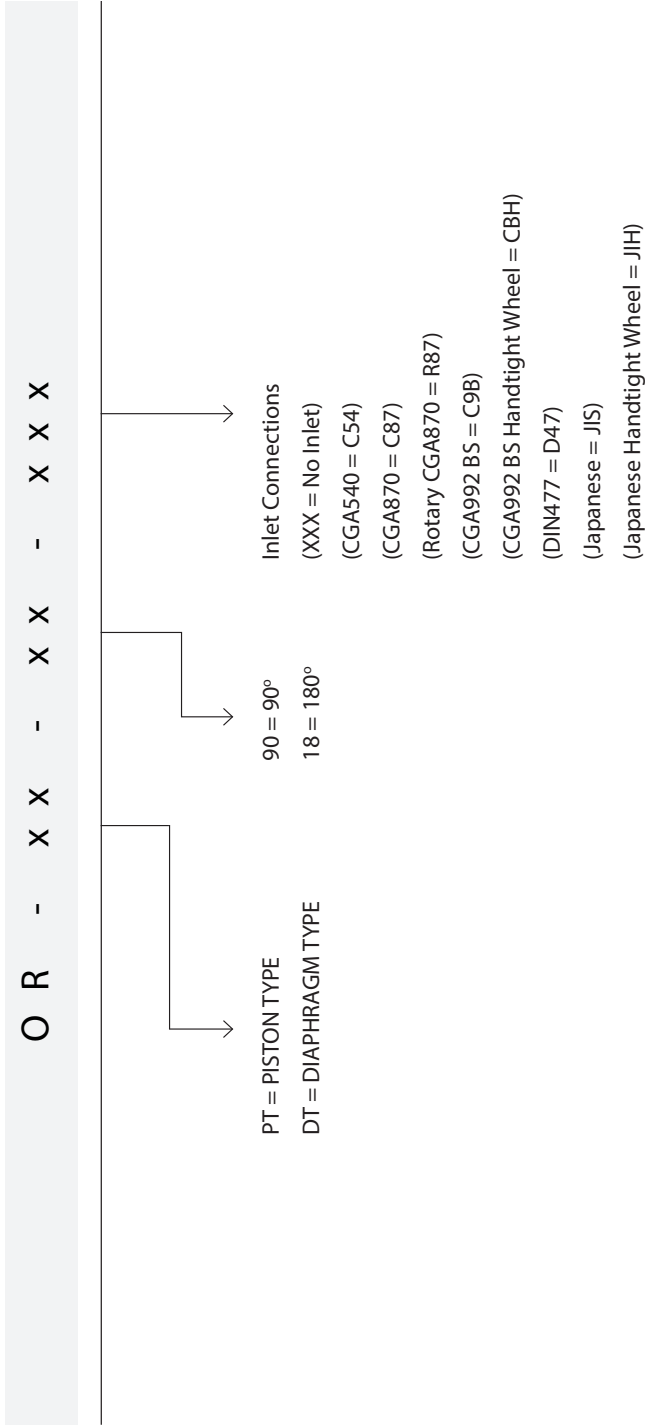



# USER MANUAL

## RESPIRATORY CARE OXYGEN REGULATOR

### IMPORTANT

OPERATING INSTRUCTIONS FOR PISTON/ DIAPHRAGM OXYGEN THERAPY REGULATORS

### **⚠ CAUTION**

PLEASE READ THOROUGHLY AND FOLLOW DIRECTIONS CAREFULLY BEFORE OPERATING EQUIPMENT.

### **⚠ WARNING**

Oxygen is a non-flammable gas, however, oxygen substantially increases its risk to becoming flammable when combined with oil, grease and other hydrocarbons. These materials should never be used or applied on any part of the oxygen cylinder, cylinder valve or other equipments used with oxygen.

### GENERAL SAFETY INFORMATION

1. These regulators are intended for the administration of oxygen to patients that are deemed by a physician to need increased oxygen levels to improve or stabilize their breathing conditions.
2. Oxygen is non-flammable gas ; however. All materials which burn in air will burn MUCH more rapidly in the presence of oxygen. OIL AND/OR GREASE BECOME HIGHLY COMBUSTIBLE IN THE PRESENCE OF OXYGEN! USE NO OIL or grease or any other petroleum based or flammable substance on or around oxygen equipment!
3. Standard industry cautions should be exercised when used in other applicable situations. These regulators may also be used in emergency situations (some models do not reach flows consistent with emergency applications). In any situation requiring emergency oxygen, call a physician or Emer



# USER MANUAL

## RESPIRATORY CARE OXYGEN REGULATOR

gency Medical Service technician immediately. This unit is an inhaler, and is useful only on persons who are breathing prior to administering oxygen.

4. If using a humidifier or similar device, remove the device from the regulator before changing the cylinder, DO NOT allow the fluids to enter.
5. Inspect the cylinder valve and regulator thoroughly for dust, oil and grease. Wipe dusty parts with a damp cloth. DO NOT USE THE CYLINDER IF OIL OR GREASE IS PRESENT! Inform your gas supplier of this condition immediately.
6. Oxygen therapy and emergency oxygen regulators are pressure reducing devices which lower the pressure of the oxygen from a cylinder to a level which can safely be used.
7. NO SMOKING - Remove matches, cigarettes, lighters and lighter fluids from the patient and from the oxygen therapy area before administering oxygen. Remove other flammable materials from the area.
8. DO NOT USE THE OXYGEN REGULATOR IF OIL, GREASE OR ANY CONTAMINATION IS PRESENT OR IF DAMAGE IS PRESENT! Take the regulator to a qualified repair technician for cleaning and/or repairing before use. Inspect the regulator inlet filter in the inlet connection to be sure it is clean. If it appears dirty, take it to a qualified repair technician for replacement.



# USER MANUAL

## RESPIRATORY CARE OXYGEN REGULATOR

### INLET CONNECTION DESCRIPTION

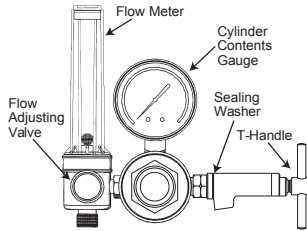

Fig. 1  
Flow Meter Regulator

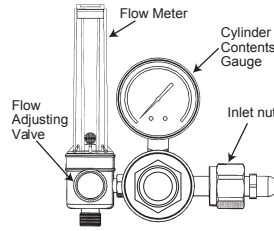

Fig. 2  
Flow Meter Regulator

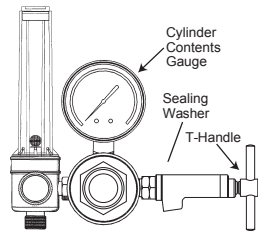

Fig. 3  
Central Type Regulator

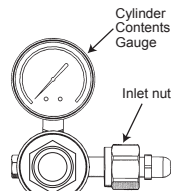

Fig. 4  
Central Type Regulator

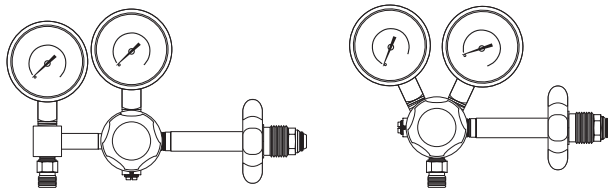

Fig. 5  
Twin-Gauge Regulator

Medical regulators come in a variety of types and models and may be equipped with one of these cylinder inlet connections.

#### Fig. 1 & 3. For REGULATORS HAVING A CGA 870 YOKE INLET CONNECTION

Turn the “T” handle clockwise to tighten the regulator, being sure the “T” handle screw point is seated in the dimple on the cylinder post valve. Tighten until secure to provide a leak proof connection.

Regulator with Yoke inlet connection.

- **CGA 870 (Pin-Index)**



# USER MANUAL

## RESPIRATORY CARE OXYGEN REGULATOR

### **Fig. 2, 4 & 5. REGULATOR WITH NUT AND SWIVEL INLET CONNECTION**

- **CGA 540 (Bull-Nose)**
- **CGA 992 (BS)**
- **DIN 477**
- **Japanese**

CGA 540, CGA992, DIN 477 or Japanese (Fig. 2, 4 & 5) with Nut and Swivel. There is no sealing washer used with this connection. Tighten this fitting to the larger cylinder valves with a wrench. For hand-tight model, please tighten the hand wheel tightly without a wrench.

### **NOTICE:**

Regulators purchased with open 1/8", 1/4", 3/8" or 1/2" NPT regulator ports must be assembled to their intended system.

Back pressure in excess of 2 PSI will cause inaccuracy of the delivery gauge reading in flow gauge regulators.

Common causes of back pressure are twisted hoses or very long hoses between the regulator outlet and user, or any restrictions to flow occurring in that area.

Some regulator models may be supplied with an open 1/4"-18NPT outlet port for connection to customers' piping. Always use thread sealants compatible with the gasses involved.

Use 15 to 20 ft.-lbs. Torque for assembly. Always leak test connections before putting into service.



# USER MANUAL

## RESPIRATORY CARE OXYGEN REGULATOR

### WARRANTY

Components of this system are warranted under use against any and all manufacturing defects from the date of purchase for 5 years. Other components are covered by their manufacturer's warranties. Any failure resulting from defective parts of faulty workmanship, as determined during evaluation by SMP Canada, will be repaired under warranty. This warranty will be voided for any unit that has been subjected to misuse, negligence, accident or repairs performed by those other than SMP Canada.

### **WARRANTY CARD**

To validate your 5 year warranty, please fill out and mail this card to SMP Canada  
within 10 days from the purchase date

MODEL \_\_\_\_\_ LOT NO. \_\_\_\_\_

YOUR NAME \_\_\_\_\_

COMPANY NAME \_\_\_\_\_

ADDRESS \_\_\_\_\_

CITY \_\_\_\_\_ STATE / PROVINCE \_\_\_\_\_

ZIP / POSTAL CODE \_\_\_\_\_ PHONE \_\_\_\_\_

PURCHASED FROM \_\_\_\_\_

DATE RECEIVED \_\_\_\_\_