

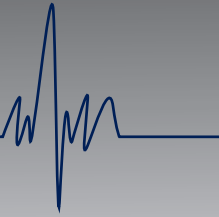

Solutions Start Here...



**Solutions Start Here**  
[www.smpcanada.com](http://www.smpcanada.com)

**SMP Canada**  
10 Sims Crescent, Richmond Hill  
Ontario, L4B-1K9 Canada  
Tel: (905) 764-7767 Fax: 1-866-627-9798  
[support@smpcanada.com](mailto:support@smpcanada.com)

## SMP 313EL

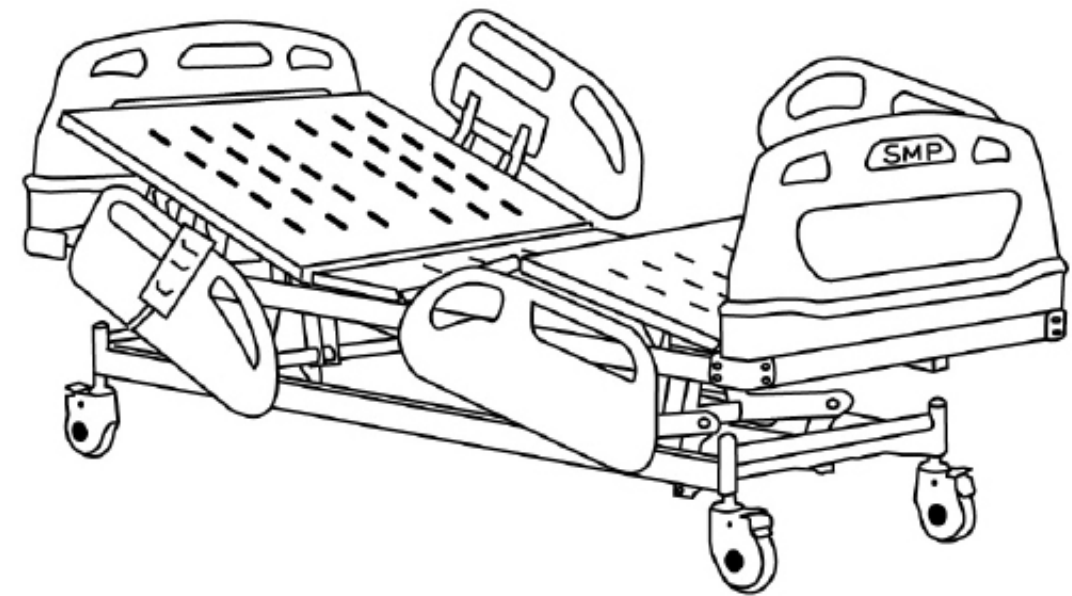

### USER & MAINTENANCE MANUAL



# USER MANUAL

## GENERAL PATIENT ROOM BED **SMP 313EL**

## About Us

We are a company that draws on innovation and excellence to provide solutions that enhance the ability for caregivers to effectively fulfill their duties. Our goal is to build a high-performing medical technology company that gives healthcare providers the tools they need to achieve better outcomes.

We are committed to helping our customers deliver safer, more efficient, technologically advanced equipment to the market place. Caregivers throughout the world look to us for solutions because we strive for excellence and adhere to their suggestions for improvement. We bring the passion, dedication, innovation and the drive in developing solutions that matter in making a difference in the lives we help save.

At SMP, we believe results speak louder than words. Our company is one that sets high standards with an emphasis on paying attention to details. We are passionate about raising the bar and regularly surpass our own ambitious goals.

Our products comply with and conform to world renowned healthcare standards such as NFPA, HTM, CSA, CE, FDA, IEC, UL and ISO 13485. We continually strive to achieve superior clinical results. We push the frontiers of medical research while maintaining uncompromising clinical integrity.

Our strategic relationship extends out to over 30 partners globally. Our partners rely on us regularly to provide quality turn-key solutions to better serve the health care industry.

We take great pride in providing accredited products that meet and exceed industry requirements.

At SMP, we don't just make promises, we deliver results!





# USER MANUAL

GENERAL PATIENT ROOM BED **SMP 313EL**

## APPENDIX C SMP-313EL

---

**User & Maintenance Manual**





# USER MANUAL

## GENERAL PATIENT ROOM BED **SMP 313EL**

### General Remarks

---

We congratulate you on your choice of an SMP-313EL hospital bed and would like to thank you for your confidence in our product.

You have purchased a SMP-313EL Hospital Bed developed and manufactured in accordance with the current state of technical knowledge.

SMP Canada's electric hospital bed fully meets all safety and operational requirements. They are tested in accordance with international standards and carry the CE seal. This confirms that they fulfill the safety requirements relating to medical products.

This user manual is intended to give you and your staff practical information and tips on the safe and correct use of the electric hospital bed.

When putting the bed into service for the first time, or when performing operations and maintenance it is highly recommended to read this manual and strictly obey this user manual.

To avoid faulty handling and to ensure trouble free operations, it is highly advised to have this document available to caregivers and/or patients at all times.

Secondary Medical Products Canada Inc.

**SMP Canada**

10 Sims Crescent

Richmond Hill, Ontario, L4B 1K9

Canada

Tel.: ++1 905-764-7767

Fax: ++1 866-627-9798

E-Mail: [info@smpcanada.com](mailto:info@smpcanada.com)

Website: [www.smpcanada.com](http://www.smpcanada.com)



# USER MANUAL

## GENERAL PATIENT ROOM BED SMP 313EL

### Table of Contents

APPENDIX C.....	1
1.) Performance Characteristics .....	5
1.1) Removeable Headboard and Footboard for easier access to the patient .....	5
1.2) 3 function hand control unit .....	5
1.3) Side rails .....	5
1.4) IV pole with 4 hooks made from stainless steel.....	5
1.5) Dual-wheel lockable castors central brake system .....	5
1.6) Back and foot adjustment allow for an anatomically correct sleep surface.....	5
1.7) 5" castors for easier maneuverability.....	6
1.8) Side bumpers.....	6
2.) Technical Data: .....	7
3.) Warranty and liability .....	8
4.) Safety Regulations .....	8
4.1) General Safety Instructions .....	8
4.2) Checking the operational safety and condition of the bed.....	9
4.3) Position of the hospital bed – Danger if falling out of bed .....	9
4.4) Four-castor central braking system – Caution! Risk of accident.....	9
4.5) Height adjustment – Risk of entrapment between bed-frame and chassis.....	9
4.6) Side Rails - Danger of entrapment .....	10
5.) Intended use.....	10
5.1) Incorrect use.....	10
6.) Before using the bed for the first time.....	11
6.1) Functional test.....	11
7.) Cleaning and disinfection .....	12
7.1) Cleaning and disinfection - Wipe and spray disinfection .....	12
8.1) Maintenance Instructions .....	13
9.) Types of Patient Positioning .....	13
10.) Operation Functions.....	14
10.1) Flat Position Height Adjustment .....	15



# USER MANUAL

## GENERAL PATIENT ROOM BED **SMP 313EL**

10.2) Leg section height adjustment .....	15
10.3) Backrest height adjustment .....	16
10.5) Installation of headboard and footboard.....	17
10.6) Installation of accessories .....	18
10.8) Use and operation of side rails.....	19
10.8.1) How to raise side rails .....	19
10.8.2) How to lower the side rails.....	19
11.2) Environment Conditions for Use .....	21



# USER MANUAL

## GENERAL PATIENT ROOM BED **SMP 313EL**

### 1.) Performance Characteristics

#### **1.1) Removeable Headboard and Footboard for easier access to the patient**

SMP's ergonomic design allows the care givers to have access to the patient's head or feet by instantly removing the headboard and footboard. See section 10.5 for details.

#### **1.2) 3 function hand control unit**

SMP-313EL bed allows you to adjust the bed in 3 different positions i.e. a) Electric adjustment of height b) Electric adjustment of upper leg c) Electric adjustment of the backrest. See section 9, 10.1, 10.2, and 10.3 for more details.

#### **1.3) Side rails**

It makes a world of a difference to have the luxury of retracting side rails installed on a bed. It can be used as added safety measure to limit the patient from rolling out of the bed or simply have it as a support for the patient to get in and out of the bed. See section 10.8, 10.8.1, and 10.8.2 for more details.

#### **1.4) IV pole with 4 hooks made from stainless steel**

Our engineers have designed the bed in a way that the IV pole can be installed in all four corners of the bed. The installation only takes a few moments so the care givers can spend more time looking after the patients. See section 10.6 for more details.

#### **1.5) Single wheel kitty corner castor brakes**

SMP-313EL is ergonomically designed with the care givers and patients in mind. That is why we have equipped this bed with a kitty corner castor brakes which can be engaged and released via simply pressing and lifting the brake level on the castors themselves. See section 10.4 for more details.

#### **1.6) Back and foot adjustment allow for an anatomically correct sleep surface**

There are times when the patient needs to sleep in an anatomically correct sleep surface. SMP-313EL allows you to adjust the backrest 0-80° and the foot section 0-40°. See section 9, 10.1, 10.2, and 10.3 for more details.



# USER MANUAL

## GENERAL PATIENT ROOM BED **SMP 313EL**

---

### **1.7) 5" castors for easier maneuverability**

SMP-313EL is ergonomically designed for the safety of the care givers and the patients. We understand that it can take a toll on the care givers body by pushing the bed with patients in it from one room to another. That is why we have designed and installed 5" castors on our bed so the care givers can have a lot less strain on their body while pushing the bed. Our castors have passed the load bearing test of the European council directive 2002/95/EC & 2005/618/EC.

### **1.8) Side bumpers**

In emergency situations, when you are pushing the bed from patient room to surgical room the last thought on your mind is to protect the bed from scrapes and scratches. That is why we have specially designed light weight bumpers and installed them on all four corners of the bed.





# USER MANUAL

## GENERAL PATIENT ROOM BED SMP 313EL

### 2.) Technical Data:

No.	Item	Unit	Parameter	
1	Size of bed board	length	mm	1925
2		width	mm	850
3		height	mm	450-700
4	Size of Headboard	length	mm	410
5		width	mm	952.68
6		depth	mm	70
7	Size of Footboard	length	mm	410
8		width	mm	952.68
9		depth	mm	70
10	Side Rails	length	mm	290
11		width	mm	750
12		depth	mm	43
13	Bed Bumpers	length	mm	50
14		width	mm	108
15		depth	mm	64
16	Angle of each bed frame	backrest	(°)	0-80° (+5°)
17		foot section	(°)	0-40°(+5°)
18	Overall size	length	mm	2130
19		width	mm	980
20		height	mm	350-700
21	IV Pole	height		870-1680
22	Castor size		inch	5"
23	Safe working load		Kg	280 kg
24	Wheel base		cm	12.7
25	Minimum under bed clearance		inch	3"
26	Castor size		inch	5"
27	Safe working load		Kg	280 kg
28	Wheel base		mm	127
29	Minimum under bed clearance		inch	3"
30	Operable Temperature Range		Celsius	+10°C to +40°C



# USER MANUAL

## GENERAL PATIENT ROOM BED SMP 313EL

31	Operable Relative Humidity Range	%	30% to 95% non- condensing
----	----------------------------------	---	----------------------------------

\* Product withstands storage/transportation in relative humidity range of 10 to 95%

\* Product withstands storage/transportation in relative humidity range of 10% to 95%

### 3.) Warranty and liability

We accept liability for possible errors and omissions within the terms of warranty laid down in the main contract. Claims for damages – from whatever legal ground they may be held to derive – are expressly excluded.

We reserve the right to make technical changes to the hospital beds described in this user's manual in accordance with technical developments.

We accept no liability whatsoever for damage and/or disruption caused by faulty handling and/or a failure to follow the instructions in this user's manual.

### 4.) Safety Regulations

The SMP electric hospital bed may only be put into service, operated and used:

- As intended by manufacturer.
- With due regard to good technical practice.
- In accordance with safety and accident-prevention regulations.

**On no account** may the bed be used in a faulty condition that could endanger patients, care givers or others.

The hospital bed may only be operated by those able to guarantee its correct handling by virtue of their professional qualifications, knowledge and/or experience.

#### 4.1) General Safety Instructions

**WARNING!** – Serious injury can be caused when moving parts of the bed. Make absolutely sure that there are no parts of the body poking through the safety frames during crank operation. Ensure without fail that there are no people, pets or objects beneath the bed.

**WARNING!** – Increased safety measures are necessary when the bed is being used:



# USER MANUAL

## GENERAL PATIENT ROOM BED SMP 313EL

- By a child under 12 years of age.
- By a person with reduced mental faculties.
- For psychiatric purposes.

**WARNING!** – In order to avoid falls, always return the bed to lowest position after each use of the adjustment functions. Make sure that:

- a) The bed is in lowest position before getting into or out of it, and
- b) The brakes are applied.

**WARNING!** – Safety frames only mark the limits of the bed. Other appropriate measures must be used to restrain patients.

**WARNING!**

- Only use original spare parts for repairs.
- Only repair bed when it is in lowest position.

### 4.2) Checking the operational safety and condition of the bed

Before putting the bed into service, it is essential to make absolutely sure that it is in good working condition and safe to use. This test must not only be carried out before first use, but continuously throughout the service life of the bed. If necessary, the bed must be tested daily or after each shift to ensure that its use does not endanger anybody. To reduce maintenance to a necessary minimum, the bed should be cleaned, disinfected and tested as soon as possible after each use so that it can be used again without delay or risk.

In cases of malfunctioning, it may be necessary to transfer the patient to another bed.

### 4.3) Position of the hospital bed – Danger if falling out of bed

In the case of unsupervised patients, we recommend that the bed is put into its lowest position to minimize the risk of injury due to falling out of bed. In other cases, the bed should be put at a height proportionate to the size of the patient.

### 4.4) Four-caster central braking system – Caution! Risk of accident

Unless in transport, the brakes must always be applied so that patients can use the bed as a support when accessing or exiting it. Serious falls can result through an unbraked bed rolling away. After applying the brakes, check that the bed is really immobile, i.e. that the brakes are fully applied to all four castors.

### 4.5) Height adjustment – Risk of entrapment between bed-frame and chassis

When adjusting the bed, make absolutely sure that no limbs, bedding or other objects are situated between the frames.



# USER MANUAL

## GENERAL PATIENT ROOM BED **SMP 313EL**

### 4.6) Side Rails - Danger of entrapment

In the case of patients whose, physical or mental state may be felt to call for the use of side rails to protect them from falling out of bed, the following safety measures **must be observed at all times:**

1. Side rails may be operated **only** by care givers instructed in their use.
2. Make sure side rails – or elements of them – are either fully raised and Locked or fully lowered.
3. During the adjustment of the mattress-frame, make sure that the patient is not touching the side rails. Also make absolutely sure that no limbs are poking through the frames.

### 5.) Intended use

SMP electric hospital beds are intended to be used solely for the care of patients in patient rooms in hospitals, clinics and/or nursing institutions.

Any use of SMP hospital beds that deviates in any way whatsoever from this intended use is expressly excluded from possible liability claims.

#### 5.1) Incorrect use

- Use of hospital bed with children under 12.
- Operation of hospital bed by patients without prior instructions.
- Connecting electrical devices to bed which are not suitable for the purpose intended (subject to management's duty of care)
- Moving the bed by pulling on mattress.
- Using the bed on sloping surfaces with gradients in excess of 10° (bed brakes designed for a maximum gradient of 10°).
- Trying to move the bed with brakes applied.
- Transporting patients by towing or pushing the bed with a vehicle.
- Using the bed with loads in excess of specified maximum safe working load.



# USER MANUAL

## GENERAL PATIENT ROOM BED **SMP 313EL**

### 6.) Before using the bed for the first time

Before the bed is put into service for the first time, this user's manual must be closely read by all those responsible for nursing care.

Before the bed is put into service for the first time, it is absolutely essential to carry out a functional test.

Before first use, care givers must receive detailed instructions on the operation of the bed. In addition, care givers must be made fully aware of potential dangers that can arise in spite of the correct operation of the bed.

#### 6.1) Functional test

A functional test **must** be carried out in the following circumstances:

1. When the bed is put into use for the first time.
2. When the bed is to be used by a new patient.
3. When the bed is put back into use after a period in storage.
4. When the bed is put back into use after cleaning and/or disinfection.
5. When it is necessary to identify incidents of malfunctioning or faults.
6. At least once a year.

The test comprises the following testing procedures that **must all** be carried out over the **full range** of adjustment:

1. Backrest adjustment
2. Upper leg section adjustment
3. Height adjustment
4. Brakes
5. Castor movement

**Warning:** Make sure all functions are working correctly. If a fault is found, the bed must be taken out of use at once and not put back into use until the fault has been corrected!



# USER MANUAL

## GENERAL PATIENT ROOM BED **SMP 313EL**

### 7.) Cleaning and disinfection

Risks can arise through the incorrect cleaning and/or disinfection of the bed.

#### 7.1) Cleaning and disinfection - Wipe and spray disinfection

The use of chemical solvents, abrasive cleaning agents of any kind and organic solvents such as halogenated or aromatic hydrocarbons and ketone is not permitted. The use of highly concentrated caustic soda is **not** permitted, either.

Follow these instructions when using cleaning agents and/or disinfectants:

- Decontaminants in the prescribed concentrations may not exceed or fall below a pH value of 6-8.
- They may not contain any corrosive or caustic substances.
- They may not contain any substances that alter surface finishes or the Adhesive properties of plastics.
- They may not affect the properties of lubricants.
- Water hardness may not exceed 0.9 mmol/l (to 5° d).

Fully desalinated water may not be used.

Chloride < 100 ppm  
Silicate as SiO<sub>2</sub> < 15 ppm  
Iron < 0,05 ppm  
Manganese < 0.01 ppm  
Copper < 0.05 ppm

This information reflects our current knowledge and experience. It does not exempt users from carrying out their own tests and trials as local conditions, e.g. water hardness, can vary. A legally binding guarantee of the nature of specific properties cannot be assumed.

We accept no liability for damage to surface finishes caused by the use of unsuitable cleaning agents and/or disinfectants, by the use of incorrect concentrations of such cleaning agents and/or disinfectants or by the incompetent or inappropriate cleaning of the bed.



# USER MANUAL

## GENERAL PATIENT ROOM BED SMP 313EL

### 8.) Service and maintenance

The SMP-313EL requires very little maintenance. All moving parts of the lifting gear, mattress-frame drives and safety frames are permanently lubricated during manufacturing process. None of these parts need re-lubrication when the bed is correctly used and cleaned. The manufacturer assumes, however, that beds are regularly inspected and damages such as worn parts, loose screws or fractures are immediately put right.

#### 8.1) Maintenance Instructions

In the case of repairs and maintenance work carried out on the bed, SMP only accepts liability for its safety and functional efficiency when:

- Delivery, maintenance and repair were carried out by a SMP Canada service technician or by a person authorized to carry out such work by SMP Canada, and
- The bed is used in accordance with the instructions given in the user's manual.

### 9.) Types of Patient Positioning

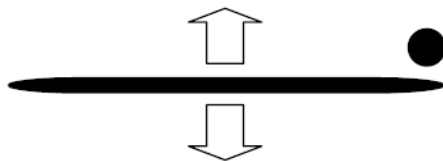

FLAT POSITION, **height adjustment**

(Figure 1)



RAISED BACKREST

(Figure 2)



# USER MANUAL

## GENERAL PATIENT ROOM BED SMP 313EL

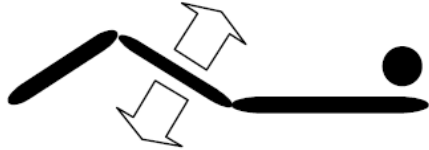

RAISED UPPER LEG SECTION  
(Figure 3)

### 10.) Operation Functions

Each function on the hand control unit comes with 2 functions. Pressing the right side of each button will lower its designated function and pressing the left side of each button will raise its designated function.

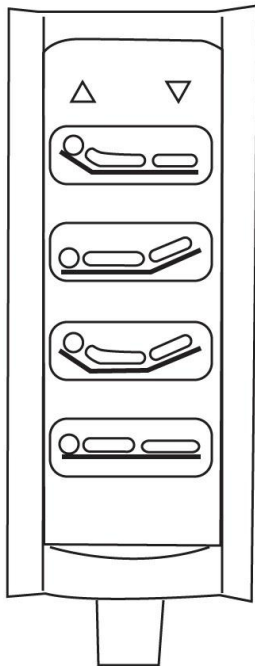





# USER MANUAL

## GENERAL PATIENT ROOM BED SMP 313EL

### 10.1) Flat Position Height Adjustment

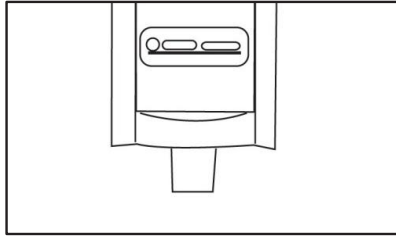

(Figure 4)

As per figure 4, press the indicated button's left side to raise the bed and pressing the right side of the button will lower the bed

### 10.2) Leg section height adjustment

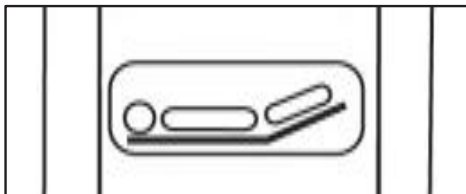

(Figure 5)

As per figure 5 press the indicated button's left side to raise the leg section and pressing the right side of the button will lower the leg section.



# USER MANUAL

## GENERAL PATIENT ROOM BED SMP 313EL

### 10.3) Backrest height adjustment

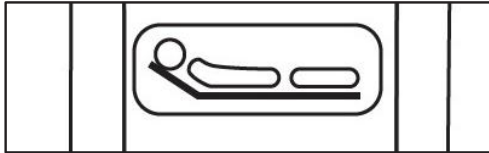

(Figure 6)

As per figure 6 press the indicated button's left side to raise the backrest section and pressing the right side of the button will lower the backrest section.

As an added bonus feature in the SMP-313EL's hand control unit, when the vascular position is desired for the bed, it can simply be achieved by pressing the button indicated in figure 7. Pressing left side of the indicated button will raise the backrest and leg section simultaneously and pressing the indicated button will lower the backrest and leg section simultaneously.

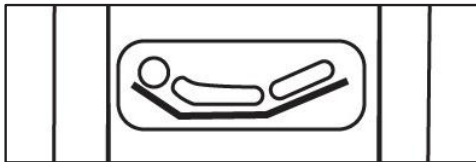

(Figure 7)

**Caution:** To prevent the hand control unit from getting damaged, please hang the unit onto the side rail using the clip attached on the back of the unit.

### 10.4) Applying & Releasing Castor Brakes

The SMP-313EL features a kitty corner castor braking system where brakes are located on the castors themselves. One castor on the head end of the bed and one castor located on the foot end of the bed features a brake. The brakes are applied by pressing down on the brake lever and released by lifting up the lever as per figure 8.

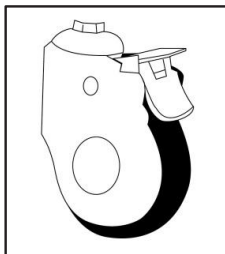

(Figure 8)



# USER MANUAL

## GENERAL PATIENT ROOM BED **SMP 313EL**

### 10.5) Installation of headboard and footboard

SMP-313EL headboard and footboard are light weight design for simple installation. To install the headboard and the footboard, screw 4 bolts (already provided in the accessories pouch) along the 4 corner slots of the bed frame.

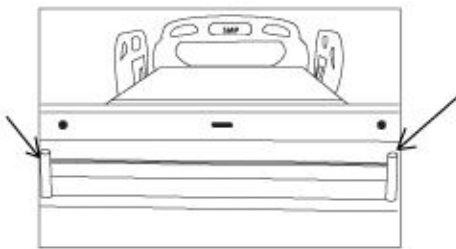

**(Figure 9)**

2 installed bolts in the corner of the bed frame. Also shown is the bottom of the footboard with the holes aligned with the bolts and the locking switch.

Align the holes at the bottom of the headboard and footboard and insert the headboard and the footboard on the bolts.

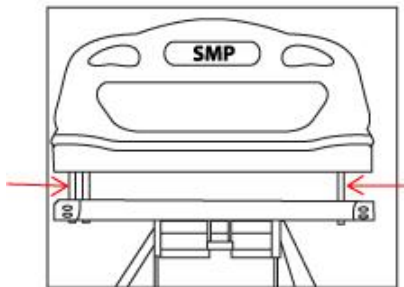

**(Figure 10)**

Installation of headboard

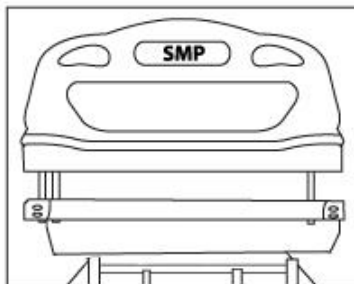

**(Figure 11)**

Installation of footboard



# USER MANUAL

## GENERAL PATIENT ROOM BED **SMP 313EL**

Lock the headboard and footboard by pushing the lock switch and rotating it 180°.

### 10.6) Installation of accessories

There are 4 adapters at the head end and the foot end of the bed to fit an IV Pole at the desired location.

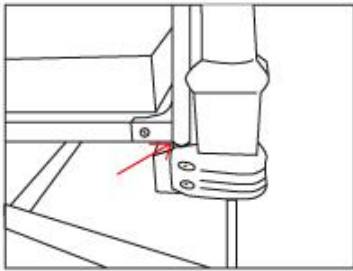

**(Figure 12)**

*IV pole installation in appropriate slot*

### 10.7) Additional accessories

A high density sponge mattress made from coco and palm fiber is available with SMP-313EL. The mattress comes in waterproof or fireproof surfaces.

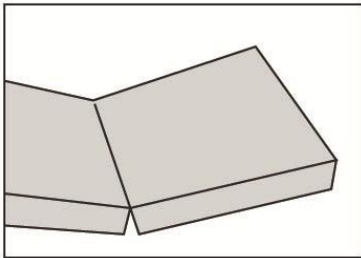

**(Figure 13)**

A height adjustable over bed table made from stainless steel is also available as an additional accessory.



# USER MANUAL

## GENERAL PATIENT ROOM BED **SMP 313EL**



(Figure 14)

### **10.8) Use and operation of side rails**

The SMP electric bed has split side rails on both sides.

When not in use, the frames are pushed down. This gives unobstructed access to the accessories bar and facilitates the use of bed jacks, even when the bed is in lowest position.

When raised, the safety frames:

- Protect patients against falling out of bed
- Support patients when accessing or exiting the bed

#### **10.8.1) How to raise side rails**

Pull side rails vertically till you hear a clicking noise. The latch locks the side rail to the frame

#### **10.8.2) How to lower the side rails**

Pull the latch (figure 15) attached to the side rail and simultaneously push the side rail down to its lowest position. To protect patients, the side rails can be raised individually or together, as appropriate. Raising all four frames provides patients with complete protection.



# USER MANUAL

## GENERAL PATIENT ROOM BED SMP 313EL



(Figure 15)  
side rail latch

The side rails can be used in four possible configurations on each side:

1. All 4 side rails fully lowered.
2. Head end side rail raised to top edge of mattress and foot end side rail lowered (aid to exiting bed) allows care givers to carry out procedures with raised safety frame.
3. Head end side rails fully raised and foot end side rails fully lowered (aid to exiting bed).
4. All 4 side rails fully raised.

These four configurations make the SMP electric bed highly flexible in use:

1. With all side rails down, care givers have unhindered access to the mattress-frame. The bed looks like a normal bed, hence contributing to a pleasant and unthreatening atmosphere.
2. With head end side rails raised to top edge of mattress and foot end side rails lowered, patients can use the side rail as an aid to getting into and out of bed. In this position, the side rails clearly mark the limits of the mattress-frame, while at the same time allowing patients to come and go at will. Furthermore, care procedures can be carried out without first having to lower the side rails.
3. With head end side rails raised and foot end side rails lowered, patients can use the side rails as an aid to getting into and out of bed. In this position, the frames clearly mark the limits of the mattress-frame, while at the same time allowing patients to come and go at will.

**Caution:** Danger of entrapment when foot end side rails are later raised!

4. When all four side rails are fully raised, patients enjoy the greatest possible protection against falling or rolling out of bed.



# USER MANUAL

## GENERAL PATIENT ROOM BED SMP 313EL

### 11.) Storage & Environmental Conditions

#### 11.1) Environmental Conditions for Transport and Storage

Condition	Range
Temperature	-40°C - + 70°C
Relative Humidity	95% non-condensing
Pressure	50kPa to 106 Kpa
Position for Transport	Must be in its lowest position, the mattress frame must be completely flat

#### 11.2) Environment Conditions for Use

Condition	Range
Temperature	10°C - 30°C
Relative Humidity	20% to 85% non-condensing
Pressure	70 kPa to 106 kPa

The bed is authorized for use solely in dry rooms, not in wet rooms such as bathrooms. The bed is mobile without the need for auxiliary transport equipment. The bed may only be moved on firm surfaces. Moving the bed over obstacles greater than 2cm in height is prohibited. Gradients may not exceed an angle of 10°.

The bed is supplied complete and can be set up without first having to remove transport equipment.