

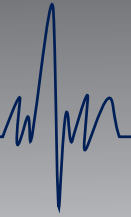

Solutions Start Here...



**Solutions Start Here**

[www.smpcanada.com](http://www.smpcanada.com)

**SMP Canada**

10 Sims Crescent, Richmond Hill  
Ontario, L4B-1K9 Canada  
Tel: (905) 764-7767 Fax: 1-866-627-9798  
[support@smpcanada.com](mailto:support@smpcanada.com)

## Tower Series

## INSTALLATION INSTRUCTION



# INSTALLATION INSTRUCTION

## POWER COLUMN TOWER SERIES



Before servicing or installing this unit please ensure that all Gas and Electrical supply has been disconnected in area of use. Please use safety and precautions at all times.

### Before Installation

Power Column are to be installed only by an experienced tradesperson. All work must conform to local building codes. Installation instructions are provided as a basis for installation of the SMP power column. Slight changes or modifications can occur at every job site.

Please read ALL instructions prior to installing the SMP power column.

The SMP approval submittal package must be reviewed before removing any power column from their shipping container. Ensure that following is correct prior to installation:

- Equipment Types and quantities match with the shipment.
- Room Numbers and Room Locations are on each package (if applicable)

Please review all approval drawings – mechanical, wiring and rough-in before proceeding with installation. If there are any discrepancies, please contact SMP Canada before you proceed with installation. (support@smpcanada.com)

### Installation

#### 1. Face Plate Removal

Remove faceplates from the Power Column

#### 2. Base Assembly Installation

Place power column base assembly on top of sway support structure located on the floor at desired location (sway support structure has to be installed by others prior to installation of the power column as it is specified on the drawings).

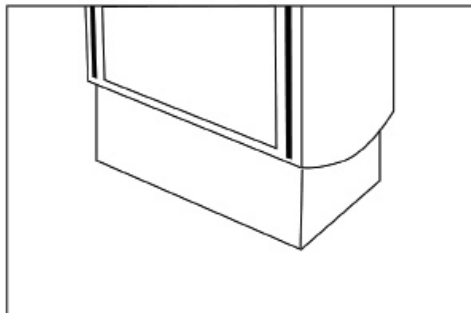



# INSTALLATION INSTRUCTION

## POWER COLUMN TOWER SERIES

### 3. Top Assembly Installation

3.1 Attach top mounting brackets to the structural ceiling (has to be done on site by others).

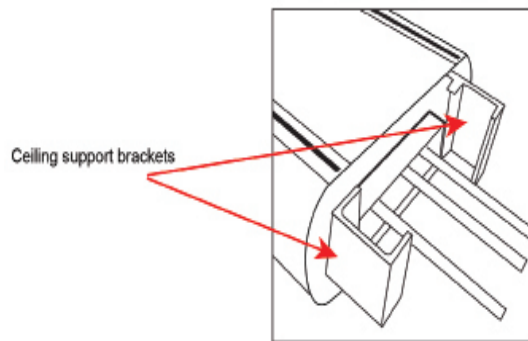

3.2 Install suspended ceiling around the Tower Series Power Column



3.3 Feed wires from ceiling through conduit attached to termination box and attach to corresponding terminal block.

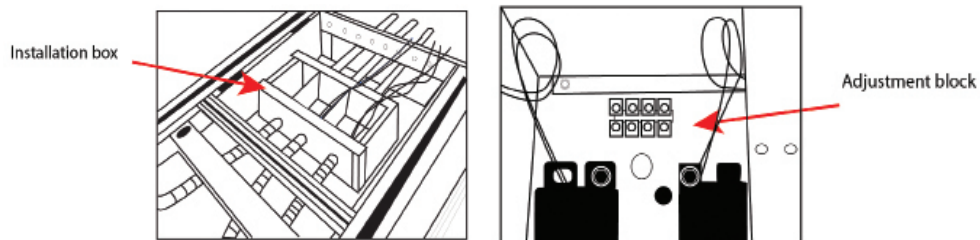

### 4. Electrical and Piping connection

Attach medical gas feeder lines from ceiling to the pipes at the top of the power column.

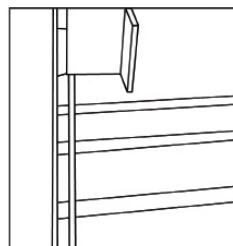



# INSTALLATION INSTRUCTION

## POWER COLUMN TOWER SERIES

### 5. Finalizing Installation

- 5.1 Test all electrical circuits, test all medical gas system.
- 5.2 Using supplied rubber suction cup, install the laminate facia by inserting the left side of the panel into the channel, place it flat against the unit then slide the other side into the corresponding channel. See pictures below

1

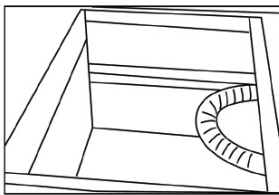

- 5.3 Insert face plates.



# INSTALLATION INSTRUCTION

## POWER COLUMN TOWER SERIES

### Finished Product





# INSTALLATION INSTRUCTION

## POWER COLUMN TOWER SERIES

### Installation Of Light

1. Take adapter from box

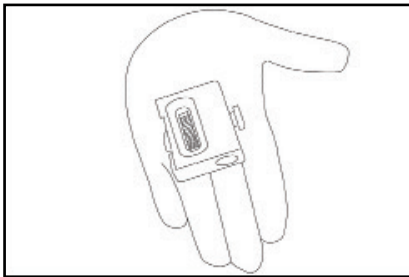

2. Loosen thumb nut to separate the screw from adapter

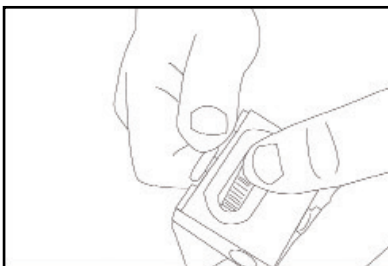

3. You now have 3 pieces

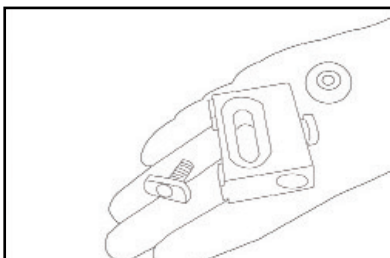

4. Take screw and insert it into the channel

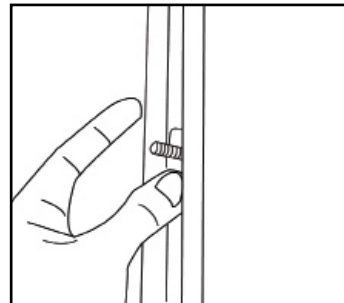

5. Screw should sit flat into the channel

6. Place thumb nut back into the body and re-tighten screw





# INSTALLATION INSTRUCTION

## POWER COLUMN TOWER SERIES

7. Adapter should sit vertically onto the headwall

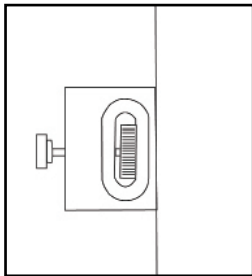

10. Re-tighten adapter thumb screw to hold light into place and ensure the light is secure

8. Place light post into the adapter hole

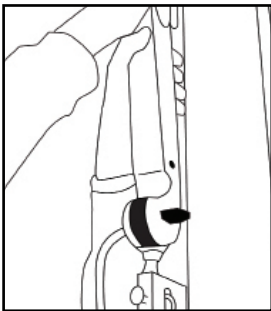

9. Loosen adapter thumb screw to allow the light to fit into the adapter

